



ASSA ABLOY

# 3500 Series

## Electric Mortise Lock Collection



ASSA ABLOY, the global leader in door opening solutions

## 3500 Series

### General Information

#### Locking/Unlocking

Solenoid locking/unlocking of lever handles and multi voltage between 12V to 24V for 3570 Electric Mortice Locks.

For the 3580 Short Backset Electric Mortice Lock the voltage is 12V or 24V.

The 3570 series has full capability for the on site selection of the following without the lock being dismantled:

- Handing of the lock to left or right hand doors.
- Setting of either the outside or both inside & outside handles being locked by the solenoid.
- Setting the locking function to either Fail Safe (Power to Lock) or Fail Secure (Power to Open), for 3570 only.

**Note: Any attempt to dismantle the locks will void warranty.**

Protection diode is included for back EMF suppression.

#### Fail Safe

- UNLOCKED with power OFF
- LOCKED with power ON

Fail Safe is not a performance warranty, but merely a descriptive term used to characterise a design feature of this device.

#### Fail Secure

- LOCKED with power OFF
- UNLOCKED with power ON

Fail Secure is not a performance warranty, but merely a descriptive term used to characterise a design feature of this device.

#### Monitoring

Monitored locks are equipped with sensors to provide status information on:

##### 1. Door furniture handle operation (3570 & 3580)

Monitored by independent microswitches on each of the two lock hubs. Left or Right Hub is selected via the 4 way DIL switch located on the lock case. The hub microswitches are generally used for monitoring the inside lever to provide Request to Exit (REX) function. The switch will always activate prior to the deadlatch microswitch activation when retracting the bolt.

##### 2. Key override monitoring (3570 & 3580)

This microswitch detects if a mechanical key has been used to retract the latch. The microswitch can be set to 'Normally Open' or 'Normally Closed' by using the settings on the lock case.

The switch will always activate prior to the deadlatch microswitch activation when

retracting the bolt.

##### 3. Bolt deadlatched and door locked status (3570 only)

Two switches wired in series achieve the above function which indicates door closed and secure. A microswitch within the lock assembly is activated when the latchbolt is deadlatched, and a microswitch is activated when the solenoid locking mechanism moves to the locked state. Thus retraction of the deadlatch or unlocking of the mechanism will break the deadlatched and door locked circuit.

##### 4. Bolt deadlatched and door closed status (3580 only)

Two switches wired in series achieve the above function which indicates door closed and deadlatched. A microswitch within the lock assembly is activated when the latchbolt is deadlatched, and a reed switch is activated

when in close proximity to the reed magnet mounted in the door jamb. Thus retraction of the deadlatch or partial opening of the door will break the deadlatched and door closed circuit.

##### 5. Door Status (3570 only)

An Isolated Door Closed Reed Switch is activated when in close proximity to the reed magnet mounted in the door jamb to indicate the door is closed.

#### Drilling, Installation, Wiring

Please read the installation instructions before attempting to install the lock.

Use ASSA ABLOY Australia accessories. Use power supplies which meet electrical specifications.

Mortice for lock must be wide enough. (Lockcase must be able to push in easily). Allow spare cable behind lock for ease of servicing.

The lockcase must not be exposed to humidity, dust or filings.

Bolt must retract and engage easily with striker plate.

Check operation of the lock after installation.

#### Specification Service

For all Architectural hardware specification assistance refer to your local ASSA ABLOY Australia Sales Office.

A fully comprehensive, obligation free, Architectural Door Hardware specification can be prepared by ASSA ABLOY Australia Architectural Hardware Consultants.

ASSA ABLOY Australia Pty Limited reserve the right to alter product specifications and embody improvements at any time as part of its continuing research and development programme of design, manufacture and materials.

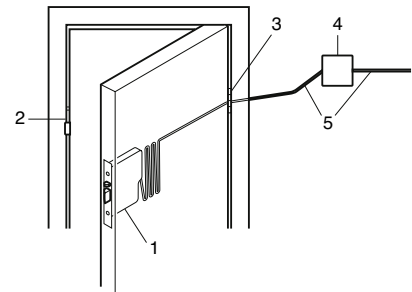

#### LEGEND

- 1 Electromechanical lock
- 2 Reed magnet and Striker plate
- 3 Power transfer device
- 4 Connection unit
- 5 Connection cable

## Contents

| <b>Description</b>                                  | <b>Page</b> |
|---|-------------|
| 3500 Series General Information                     | 2           |
| 3570 Series Function Chart                          | 4           |
| 3570 Series Electrical Specifications               | 5           |
| 3570 Series Standard Backset Features               | 6           |
| 3570 Series Standard Backset Specifications         | 7           |
| 3570 Series Standard Backset Ordering Procedure     | 8           |
| 3570 Series Standard Backset Accessories            | 9           |
| 3580 Series Short Backset Function Chart            | 10          |
| 3580 Series Short Backset Electrical Specifications | 11          |
| 3580 Series Short Backset Features                  | 12          |
| 3580 Series Short Backset Specifications            | 13          |
| 3580 Series Short Backset Ordering Procedure        | 14          |
| 3580 Series Short Backset Accessories               | 15          |

# 3500 Series Electric Mortice Lock

## 3570 Series

### Function Chart

The 3500 Series electric lock allows doors to be electrically locked and unlocked. They can be operated by pushbuttons, intercom systems and key switches or higher security devices such as keypads and card readers.

The feature list includes the following:

- Field reversible Fail Safe, Fail Secure configuration.
- Field changeable monitoring contacts between normally closed (N/C) and normally open (N/O) for key override monitoring and hub monitoring.
- Field reversible mechanical handing to suit left hand (LH) and right hand (RH) swinging doors.
- Field changeable selection of free lever or locked lever on both sides of the door.
- Multi-voltage - will work on 12 - 24 VDC systems.
- Reduced stock levels due to field changeable options.

### 3572 Series Vestibule Locks

Deadlatching functions with single action escape feature, the inside handle remaining free at all times.

#### Lock Operation

**Outside:** Open by handle except when handle is locked by solenoid.

Open by key where applicable at all times.

**Inside:** Open by handle at all times.

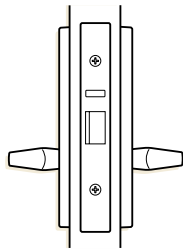

**Non-Monitored Lock (Reversible)**  
3572ELNO Series

**Monitored Lock (Reversible)**  
3572ELMO Series

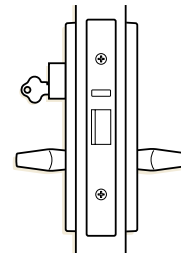

**Non-Monitored Lock with Key Override (Reversible)**  
3572ELN1 Series

**Monitored Lock with Key Override (Reversible)**  
3572ELM1 Series

### 3574 Series Combination Locks

Deadlatching functions with latchbolts operated by exterior or interior handles except when both handles have been locked.

#### Lock Operation

**Outside:** Open by handle except when handle is locked by solenoid.

Open by key where applicable at all times.

**Inside:** Open by handle except when handle is locked by solenoid.

Open by key where applicable at all times.

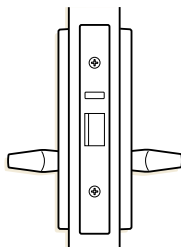

**Non-Monitored Lock (Reversible)**  
3574ELNO Series

**Monitored Lock (Reversible)**  
3574ELMO Series

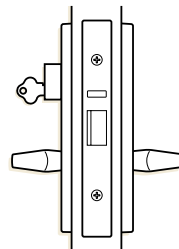

**Non-Monitored Lock with Key Override (Reversible)**  
3574ELN1 Series

**Monitored Lock with Key Override (Reversible)**  
3574ELM1 Series

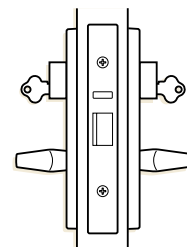

**Non-Monitored Lock with Key Override Both Sides (Reversible)**  
3574ELN2 Series

**Monitored Lock with Key Override Both Sides (Reversible)**  
3574ELM2 Series

# 3500 Series Electric Mortice Lock

## 3570 Series (continued)

### Electrical Specifications

#### Circuit Diagram

Note: Diagram depicts fail safe RH opened door, with handle and key in rest state.

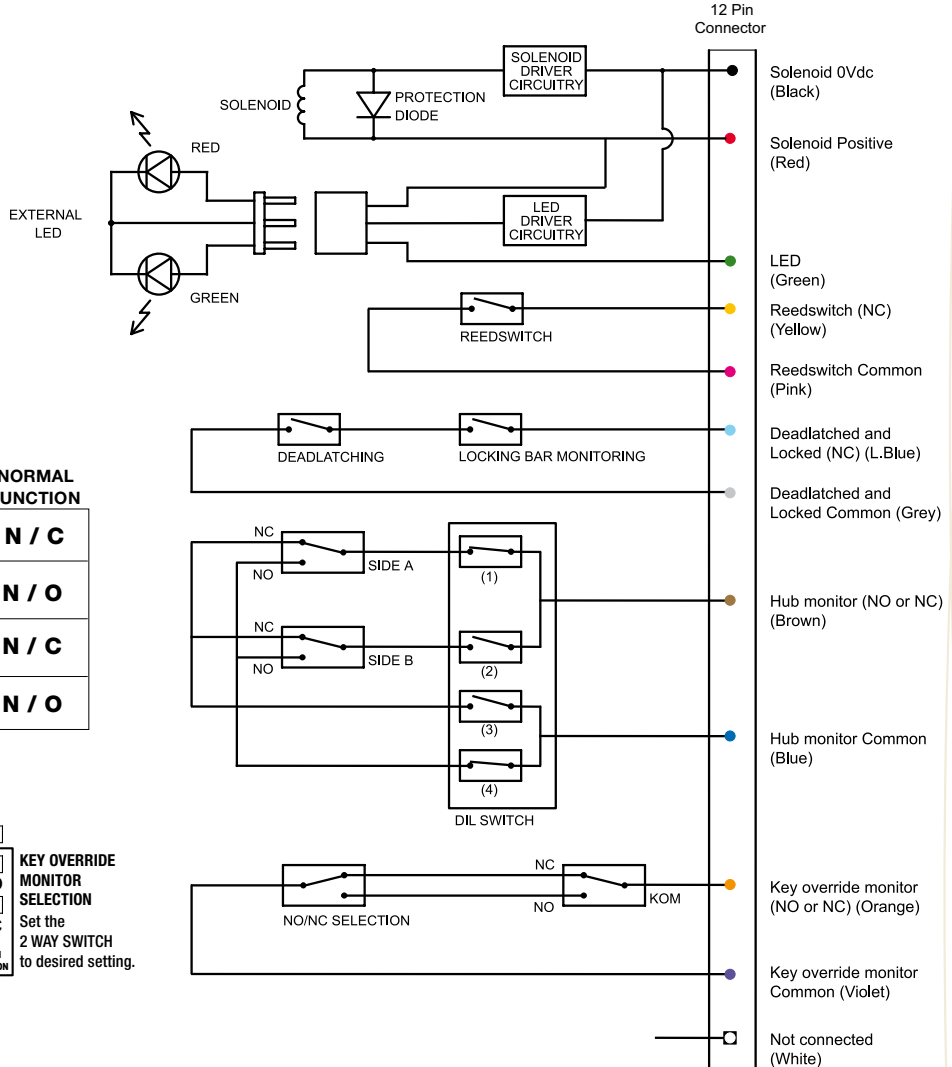
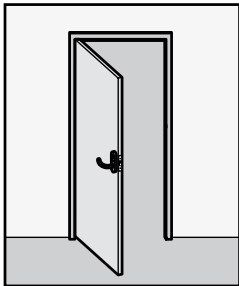

#### DIL Switch Settings

##### HUB MONITOR

|    | SWITCH No. |    |     |     | LOCK SIDE | NORMAL FUNCTION |
|----|------------|----|-----|-----|-----------|-----------------|
|    | 1          | 2  | 3   | 4   |           |                 |
| ON | OFF        | ON | OFF | ON  | A         | N / C           |
| ON | OFF        | ON | OFF | ON  | A         | N / O           |
| ON | OFF        | ON | OFF | OFF | B         | N / C           |
| ON | OFF        | ON | OFF | OFF | B         | N / O           |

##### KEY OVERRIDE MONITOR SELECTION

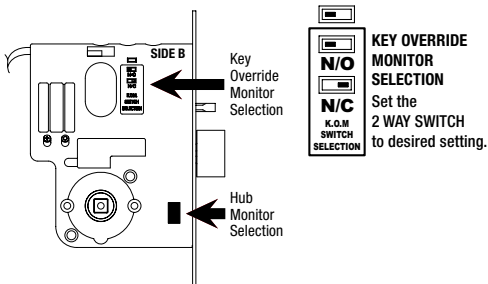

### Electrical Specifications

#### Solenoid Activation

Operating Voltage:  
12 - 24V dc

Operating Current:  
500mA (max) 80mA holding @ 12V dc  
275mA (max) 50mA holding @ 24V dc

For confirmation of the above mentioned operating current, please see installation manual.

#### LED Current

Where LEDs are fitted, add 20mA (max) to total operating current.

#### Monitoring Circuits

Microswitches: 500mA (max) @ 30V dc each circuit  
Reedschwitch: 100mA (max) @ 30V dc

#### Colour

|            |                                     |
|------------|-------------------------------------|
| Black      | Solenoid (0V dc)                    |
| Red        | Solenoid Positive (12V dc - 30V dc) |
| Green      | LED (12V dc - 30V dc)               |
| Yellow     | Door closed. Reedschwitch (NC)      |
| Pink       | Reedschwitch (common)               |
| Light Blue | Deadlatched and Locked (NC)         |
| Grey       | Deadlatched and Locked (common)     |
| Brown      | Hub monitor (NO or NC)              |
| Blue       | Hub monitor (common)                |
| Orange     | Key override monitor (NO or NC)     |
| Violet     | Key override monitor (common)       |
| White      | Not connected                       |

# 3500 Series Electric Mortice Lock

## 3570 Series Standard Backset

### Features

#### Patent Protection

The following features are protected by patents in Australia and overseas.

- Hub selection.
- Cylinder fixing.
- Hub monitoring.
- Deadlocking monitoring.
- Key override monitoring.

#### Hub Selection

Cam operated adjustment of locking members attached to the snib and accessible through the lock body from the outside to set hubs as required.

#### Latch Bolt

Reversible for both left and right hand doors opening in or opening out without disassembly.

Standard deadlatch configuration.

Separate auxiliary bolt moves into lock case simultaneously with latch bolt.

Bolt – standard stainless steel fire rated up to 4 hours.

#### Strike

Universal stainless steel strike suitable for up to 4 hour fire rating applications.

#### Door Thickness

Standard applications 32 to 50 mm.

#### Backsets

60 mm standard, 89 and 127 mm available on application.

#### Cylinder/Adaptor Retention

Patented "Slip Pin" Cylinder/Adaptor fixing method, which allows attachment to the case by inserting a non threaded cylindrical pin through the front of the lock case.

#### Multi-Function Lock

Lock is designed to significantly reduce stock line items.

Standard cylinder mortice lock can be converted from escape function to combination function by simple manipulation of hub snibs without lock case disassembly. Field selectable Fail Safe or Fail Secure Function.

#### Case Assembly

High purity zinc alloy case and back plate.

#### Cylinder Assembly

Existing cylinder assemblies ie, same "X" cams as the ASSA ABLOY Australia Lockwood 570 Oval Cylinder Assemblies.

#### LED Connection

Right or left hand connection points for status LED's.

#### Hub Monitor Selection Switch

Select normally open, normally closed, right hand or left hand hub monitoring combinations.

#### Key Override Monitor Selection Switch

Select normally open or normally closed configuration.

#### Door Position Switch

Reed switch located within lock housing.



# 3500 Series Electric Mortice Lock

## 3570 Series Standard Backset (continued)

### Specifications

#### Case & Cover

High purity zinc alloy material cases and stainless steel cover plates. Brass plates provided for plated finishes.

#### Backset

60 mm standard backset. Extended backsets 89 and 127 mm are available on application.

#### Latchbolts & Deadlatching

Latchbolts are 15 mm stainless steel. Deadlatching is achieved by an auxiliary stainless steel latchbolt. This auxiliary bolt retracts when the main latchbolt is withdrawn and is depressed when the door is closed.

#### Door Clearance

To ensure correct functioning of the deadlatching mechanism and security for all locks, the clearance between the door and frame should be 3 mm. However the deadlatching will operate up to 6.5 mm door clearance.

#### Door Thickness

32 to 50 mm. Doors greater than 50 mm will require accessories with extended lengths. Refer to Lockwood Spare Parts Price List for details.

#### Extended Cylinders

Extended cylinders are available where door thickness exceeds 50 mm. Refer to ASSA ABLOY Australia Keying & Restricted Profiles Price List for further information.

#### Security

All 3570 Series Electric Mortice Locks conform with Level S3 (Physical Security) Australian Lock Standard (AS 4145.2: 1993).\*

\* When used with a high security keying system such as ABLOY Protec or Lockwood TWIN Keying Systems. Level S2 applies with lower security keying systems.

#### Durability

All 3570 Series Electric Mortice Locks conform with level D3 (Durability) Australian Lock Standard (AS 4145.2: 1993).

#### Lock/Cable Connection

Unless otherwise ordered, 1.6 meters length of cable with a 12 pin socket will be supplied with each lock. All locks will be supplied with a positive latching 12 pin plug, emanating from the top of the lock on a short length of cable.

#### Door Furniture

All Lockwood and Efc0 Series door furniture can be used with the 3570 range of Electric Mortice Locks. Refer to the ASSA ABLOY Australia Commercial Security Price Book for further information.

#### Door Furniture with Visual Indication

All monitored locks are equipped to visually indicate the lock's status. If this feature is required, door furniture plates incorporating Light Emitting Diodes are available in Lockwood furniture.

### Fire Doors



Lockwood 3570 Series Electric Mortice Locks have been successfully fire tested up to 4 hours on fire door assemblies in accordance with Australian Standard AS 1905.1 - 2005, Part 1: Fire-resistant doorsets.

#### Rebate

Rebate kits to suit 13 mm standard rebate are available.

### Keying

#### Cylinder

Standard ASSA ABLOY Australia oval shaped cylinders and plugs.

#### Standard Keying

Supplied individually keyed 5 pin cylinder with 2 keys per lock. 78,000 key combinations. Key blank KB2015P.

#### Special Keying

Lockwood Electric Mortice Locks are available specially keyed. Refer to the ASSA ABLOY Australia Keying & Restricted Profiles Price List for further information.

### Standard Finishes

Satin Chrome SC

Note: For optional finishes, face plates and screw packs are available in CP and PB. Refer to section 10 of the commercial price book for further details.

### Limiting Dimensions

| Dimension | Backset |     |     |
|-----------|---------|-----|-----|
|           | 60      | 89  | 127 |
| A         | 60      | 89  | 127 |
| B         | 100     | 129 | 167 |

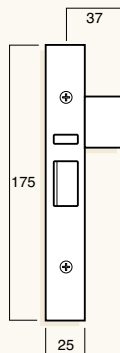
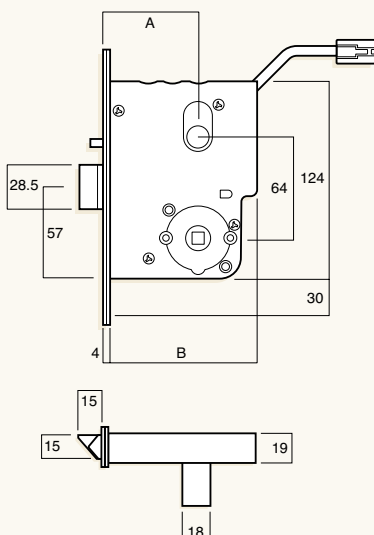

#### Reed Magnet

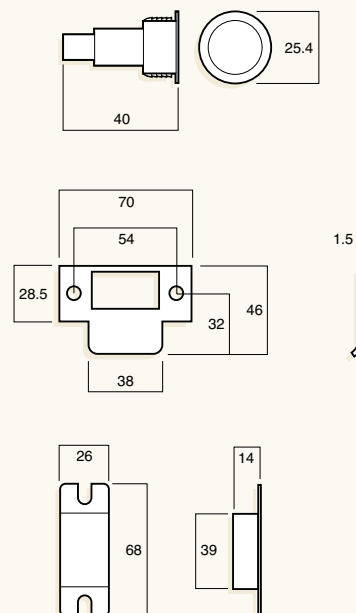

# 3500 Series Electric Mortice Lock

## 3570 Series Standard Backset (continued)

### Ordering Procedure

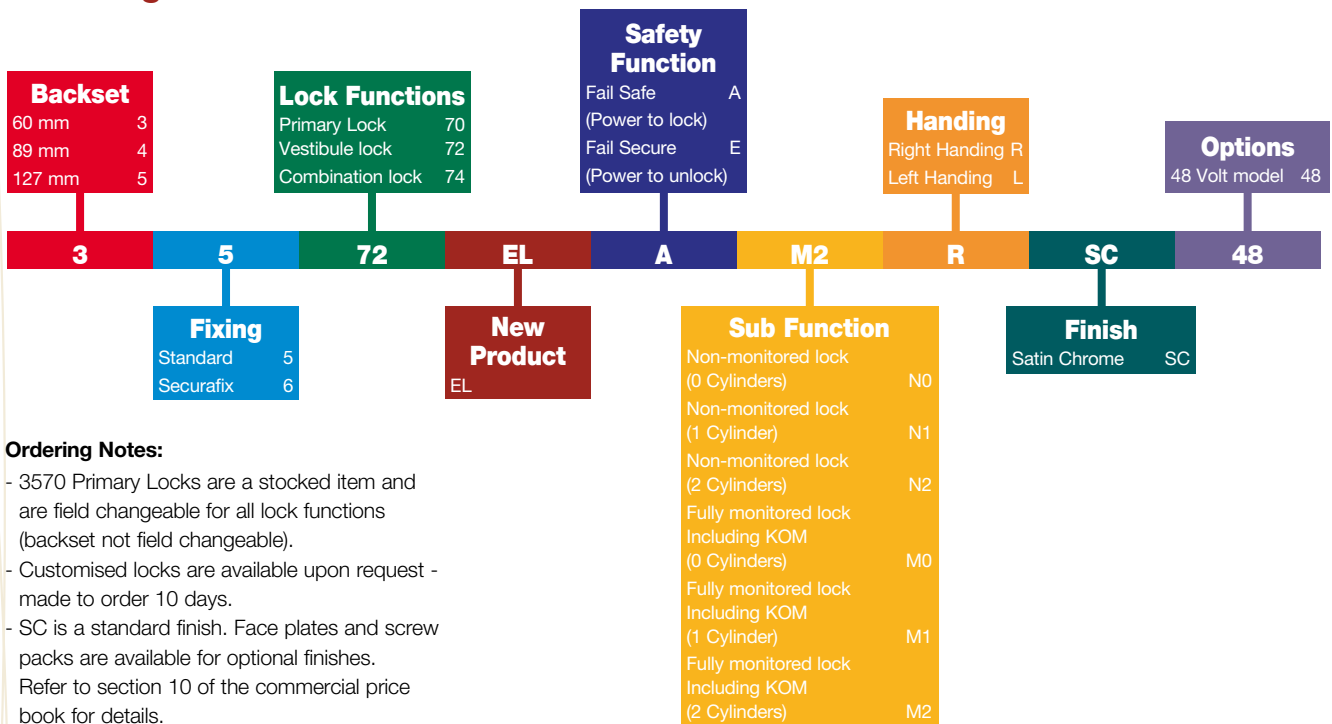

#### Ordering Notes:

- 3570 Primary Locks are a stocked item and are field changeable for all lock functions (backset not field changeable).
- Customised locks are available upon request - made to order 10 days.
- SC is a standard finish. Face plates and screw packs are available for optional finishes. Refer to section 10 of the commercial price book for details.

#### Rebated Doors

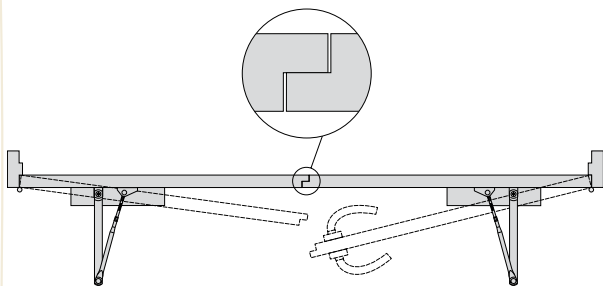

#### Handing Chart

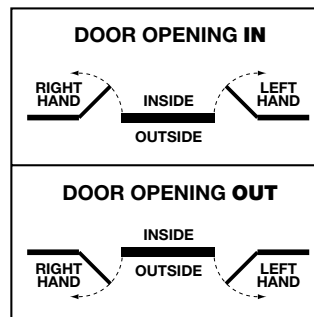

#### Backset

Nominate backset as required, eg 60mm

3

#### Fixing

Select the desired fixing method, eg Standard Fixing

35

#### Lock Functions

Select function, eg Vestibule Lock

3572

#### Electrical Variant

Indicate that this is an Electric Lock - New Model

3572EL

#### Safety Function

Select whether lock should Fail Secure or Fail Safe, eg Fail Safe

3572ELA

#### Monitoring and Key Override Options

Select monitoring and cylinders to be supplied, eg Fully Monitored Lock Including KOM with 2 cylinders

3572ELAM2

#### Handing

Determine left or right handing, eg Right Handing

3572ELAM2R

#### Finish

Select appropriate finish, eg Satin Chrome

3572ELAM2RSC

#### Options

Select 48VDC coil when required, otherwise leave blank (Lock is multivoltage by default, eg 12-24V)

3572ELAM2RSC48

# 3500 Series Electric Mortice Lock

## 3570 Series Standard Backset (continued)

### Accessories

#### Long Lipped Strikes

| Finish                | "A"  | Part No         |
|-----------------------|------|-----------------|
| Bright Chrome         | 43.5 | 3570 – 5253 BC  |
|                       | 47.5 | 3570 – 5453 BC  |
| Polished Brass        | 43.5 | 3570 – 5353 PB  |
|                       | 47.5 | 3570 – 5553 PB  |
| Satin Stainless Steel | 43.5 | 3570 – 5353 SSS |
|                       | 47.5 | 3570 – 5553 SSS |

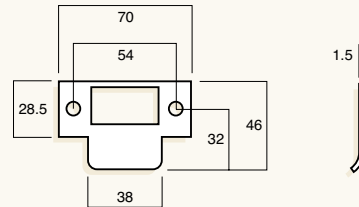

#### Rebate Kits

| Finish                | "A" | Part No         |
|-----------------------|-----|-----------------|
| Bright Chrome         | 32  | 3570 – 2905 CP  |
|                       | 46  | 3570 – 3905 CP  |
| Polished Brass        | 32  | 3570 – 2905 PB  |
|                       | 46  | 3570 – 3905 PB  |
| Satin Chrome          | 32  | 3570 – 2905 SC  |
|                       | 46  | 3570 – 2905 SC  |
| Satin Stainless Steel | 32  | 3570 – 2905 SSS |
|                       | 46  | 3570 – 3905 SSS |

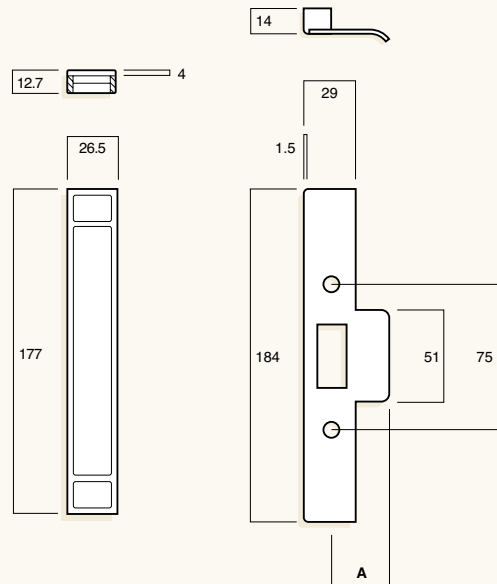

#### Extended Cylinders

Extended cylinders should be considered when door thickness exceeds 50 mm or when the lock is mounted off centre in the door edge. A range of cylinders is available to suit various door thicknesses.

Refer to ASSA ABLOY Australia Keying and Restricted Price List for further information.

| "A"<br>Cylinder<br>Projection | Cylinder<br>Length | Recommended<br>Door Thickness<br>(lock central) |
|-------------------------------|--------------------|---|
| 41                            | 37                 | 50 to 60  |
| 52                            | 48                 | 60 to 84  |
| 64                            | 60                 | 84 to 108                                       |
| 80                            | 76                 | 108 to 132                                      |
| 88                            | 84                 | 132 to 156                                      |

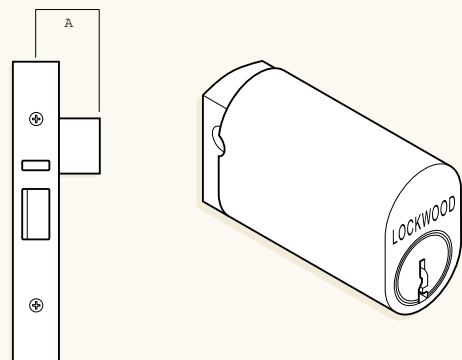

# 3500 Series Electric Mortice Lock

## 3580 Series

### Function Chart

The 3580 Series electric lock allows doors to be electrically locked and unlocked. They can be operated by pushbuttons, intercom systems and key switches or higher security devices such as keypads and card readers.

The feature list includes the following:

- Field changeable handing to suit left hand (LH) and right hand (RH) doors.
- Field changeable selection of free lever or locked lever on both sides of the door.
- Key override with monitoring of key operation.
- Lever is locked and unlocked electrically.
- Door closed and deadlatched monitoring (door sealed indication).
- Lever rotation monitoring (request to exit).
- Field changeable contacts - normally closed (N/C), normally open (N/O) for key override monitoring and hub monitoring.
- Reduced stock levels due to field changeable options.

### 3582 Series Vestibule Locks

Deadlatching functions with single action escape feature, the inside handle remaining free at all times.

#### Lock Operation

**Outside:** Open by handle except when handle is locked by solenoid.  
Open by key where applicable at all times.

**Inside:** Open by handle at all times.

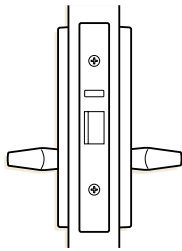

**Non-Monitored Lock (Reversible)**  
3582ELNO Series  
**Monitored Lock (Reversible)**  
3582ELMO Series

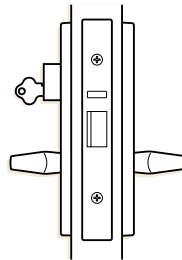

**Non-Monitored Lock with Key Override (Reversible)**  
3582ELN1 Series  
**Monitored Lock with Key Override (Reversible)**  
3582ELM1 Series

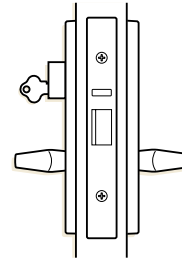

**Monitored Lock with Monitored Key Override (Handed)**  
3582ELM4 Series (no cylinder supplied)  
3582ELM5 Series (with cylinder)

### 3584 Series Combination Locks

Deadlatching functions with latchbolts operated by exterior or interior handles except when both handles have been locked.

#### Lock Operation

**Outside:** Open by handle except when handle is locked by solenoid.  
Open by key where applicable at all times.

**Inside:** Open by handle except when handle is locked by solenoid.  
Open by key where applicable at all times.

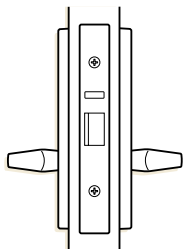

**Non-Monitored Lock (Reversible)**  
3584ELNO Series  
**Monitored Lock (Reversible)**  
3584ELMO Series

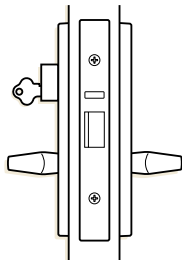

**Non-Monitored Lock with Key Override (Reversible)**  
3584ELN1 Series  
**Monitored Lock with Key Override (Reversible)**  
3584ELM1 Series

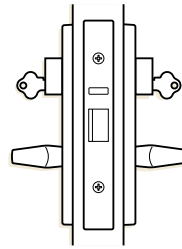

**Non-Monitored Lock with Key Override Both Sides (Reversible)**  
3584ELN2 Series  
**Monitored Lock with Key Override Both Sides (Reversible)**  
3584ELM2 Series

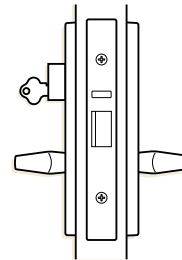

**Monitored Lock with Monitored Key Override (Handed)**  
3584ELM4 Series (no cylinder supplied)  
3584ELM5 Series (with cylinder)

# 3500 Series Electric Mortice Lock

## 3580 Series (continued)

### Electrical Specifications

#### Circuit Diagram

Note: Diagram depicts fail safe 12V RH opened door, with handle and key in rest state.

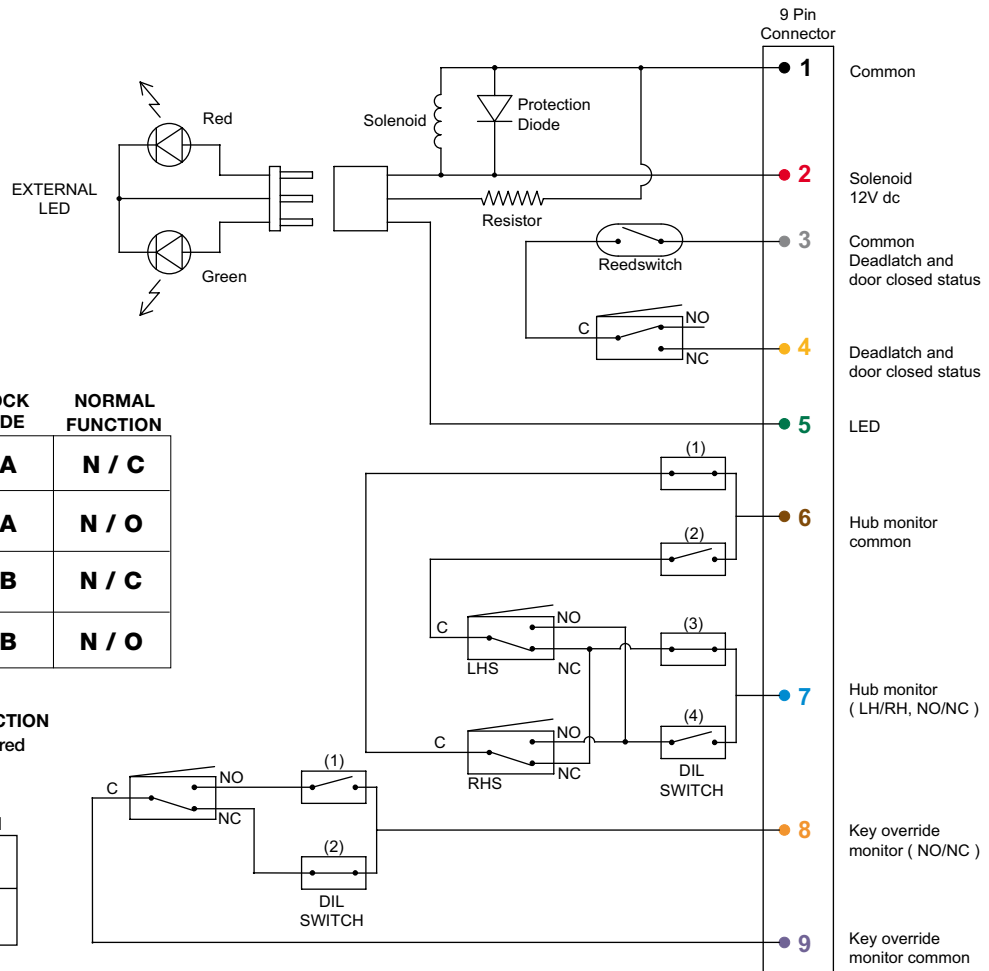
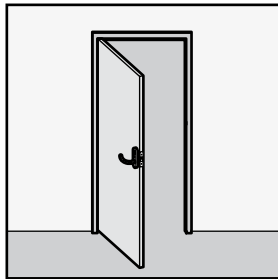

#### DIL Switch Settings

##### HUB MONITOR

|     | SWITCH No. |   |   |   | LOCK SIDE | NORMAL FUNCTION |
|-----|------------|---|---|---|-----------|-----------------|
|     | 1          | 2 | 3 | 4 |           |                 |
| ON  | ■          | ■ | ■ | ■ | A         | N / C           |
| OFF | □          | □ | □ | □ |           |                 |
| ON  | ■          | ■ | □ | ■ | A         | N / O           |
| OFF | □          | □ | ■ | □ |           |                 |
| ON  | ■          | ■ | ■ | ■ | B         | N / C           |
| OFF | □          | □ | □ | □ |           |                 |
| ON  | ■          | ■ | ■ | ■ | B         | N / O           |
| OFF | □          | □ | □ | □ |           |                 |

##### KEY OVERRIDE MONITOR SELECTION

Set the 2 WAY DIL SWITCH to desired setting, refer to table.

|     | SWITCH No. |   | NORMAL FUNCTION |
|-----|------------|---|-----------------|
|     | 1          | 2 |                 |
| ON  | ■          | ■ | N / O           |
| OFF | □          | □ |                 |
| ON  | ■          | ■ | N / C           |
| OFF | □          | □ |                 |

#### Electrical Specifications

##### Hub Snib Activation (Solenoid Activated)

12V dc ± 5% 250mA (max)

24V dc ± 5% 125mA (max)

##### Hub/Deadlatch/Key override monitor

Miniature lever microswitch

max ratings 500mA @ 30V dc

##### Door Status Monitor

Miniature magnetic reed switch

max ratings 3W, 250mA (max) @ 12V dc

125mA (max) @ 24V dc

##### LED Current

Where LEDs are fitted, add 15mA (max) to total operating current.

##### Plug Arrangements

3580 - 9 pin plug supplied with 3.6 m of cable.

| Pin | Colour | Function                                  |
|-----|--------|---|
| 1   | Black  | Common (0V dc)                            |
| 2   | Red    | Solenoid (12V dc or 24V dc)               |
| 3   | Grey   | Deadlatch and door closed status (common) |
| 4   | Yellow | Deadlatch and door closed status          |
| 5   | Green  | LED                                       |
| 6   | Brown  | Hub monitor (common)                      |
| 7   | Blue   | Hub monitor (RH/LH, NO/NC)                |
| 8   | Orange | Key override monitor (NO/NC)              |
| 9   | Violet | Key override monitor (common)             |

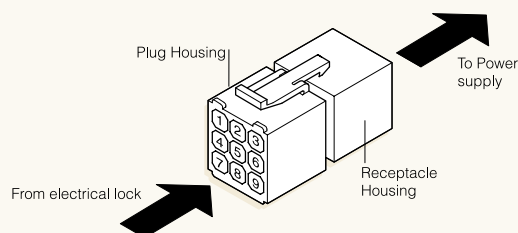

# 3500 Series Electric Mortice Lock

## 3580 Series Short Backset

### Features

#### Patent Protection

The following features are protected by patents in Australia and overseas.

- Hub selection.
- Cylinder fixing.
- Hub monitoring.
- Deadlocking monitoring.
- Key override monitoring.

#### Hub Selection

Sliding adjustable locking members attached to the snib, screw fixed in either the operative or inoperative positions, accessible from the outside of the lock body to set hubs as required.

#### Latch Bolt

Reversible for both left and right hand doors, opening in or opening out without disassembly.

Standard deadlatch configuration only, 15 mm stainless steel material.

Separate auxiliary bolt moves into lock case simultaneously with latch bolt.

#### Strike

Brass material to suit inward/outward opening doors to conform to Australian Lock Standard universal strike.

#### Door Thickness

Timber doors: 32 to 50 mm.

Metal doors: 35 to 50 mm.

#### Backsets

Standard Backset – 23 mm.

Other backsets available on application 25.4 mm, 30 mm and 38 mm.

#### Cylinder/Adaptor Retention

Patented "Slip Pin" Cylinder/Adaptor fixing method, which allows attachment to the lock case by inserting a non threaded cylindrical pin through the front of the lock case.

#### Multi-Function Lock

Lock is designed to significantly reduce stock line items.

Standard cylinder mortice lock can be converted from escape function to combination function by simple manipulation of hub snibs without lock case disassembly.

#### Rebate Kits

Rebate kits suitable for timber doors with a minimum backset of 30 mm.

#### Case Assembly

High purity zinc alloy case and back plate.

#### Cylinder Assembly

Existing cylinder assemblies ie, same "X" cams as Lockwood 570 oval cylinder assemblies.

#### Lock Fixing

Fabricator pack fixing.

#### LED Connection

Right or left hand connection points for status LED's.

#### Hub Monitor Selection Switch

Select normally open, normally closed, right hand or left hand hub monitoring combinations.

#### Key Override Monitor Selection

Select normally open or normally closed configuration.

#### Door Position Switch

Reed switch located within lock housing.

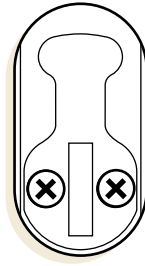

# 3500 Series Electric Mortice Lock

## 3580 Series Short Backset (continued)

### Specifications

#### Case & Cover

High purity zinc alloy material cases and stainless steel cover plates. Brass plates provided for plated finishes.

#### Backset

23 mm standard backset. Extended backsets 25.4, 30 and 38 mm are available on application.

#### Latchbolts & Deadlatching

Latchbolts are 15 mm stainless steel. Deadlatching is achieved by an auxiliary stainless steel latchbolt. This auxiliary bolt retracts when the main latchbolt is withdrawn when the door is closed.

#### Door Clearance

To ensure correct functioning of the deadlatching mechanism and security for all locks, the clearance between the door and frame should be 3 mm. However the deadlatching will operate up to 6.5 mm door clearance.

#### Door Thickness

32 to 50 mm. Doors greater than 50 mm will require accessories with extended lengths. Refer to the Lockwood Spare Parts Price List for details.

#### Extended Cylinders

Extended cylinders are available where door thickness exceeds 50 mm. Refer to the ASSA ABLOY Australia Keying & Restricted Profiles Price List for further information.

#### Security

All 3580 Series Electric Mortice Locks conform with Level S2 (Physical Security) Australian Lock Standard (AS 4145.2: 1993).\*

\* When used with a high security keying system such as Lockwood V7. Level S2 applies with lower security keying systems.

#### Durability

All 3580 Series Electric Mortice Locks conform with level D3 (Durability) Australian Lock Standard (AS 4145.2: 1993).

#### Lock/Cable Connection

Unless otherwise ordered, 3.6 meters length of cable with a 9 pin socket will be supplied with each lock. All locks will be supplied with a positive latching 9 pin plug, emanating from the top of the lock on a short length of cable.

#### Door Furniture

Lockwood and EfcO Series door furniture can be used with the 3580 range of Electric Mortice Locks. Refer to the Lockwood Commercial Security Price Book for further information.

#### Door Furniture with Visual Indication

All monitored locks are equipped to visually indicate the lock's status. If this feature is required, door furniture plates incorporating Light Emitting Diodes are available in Lockwood furniture.

#### Rebate

Rebate kits to suit 13 mm standard rebate are available.

#### Keying

##### Cylinder

Standard Lockwood oval shaped, brass cylinders and brass plugs.

##### Standard Finishes

Supplied individually keyed 5 pin cylinder with 2 keys per lock. 78,000 key combinations. Key blank KB2015P.

##### Special Finishes

Lockwood Electric Mortice Locks are available specially keyed. Refer to the ASSA ABLOY Australia Keying & Restricted Profiles Price List for further information.

#### Standard Finishes

|                |    |
|----------------|----|
| Bright Chrome  | CP |
| Polished Brass | PB |
| Satin Chrome   | SC |

### Limiting Dimensions

| Dimension | Backset |      |      |      |
|-----------|---------|------|------|------|
|           | 23      | 25.4 | 30   | 38   |
| X         | 23      | 25.4 | 30   | 38   |
| Y         | 36.4    | 39   | 43.6 | 51.7 |
|           | 40      | 43   | 48   | 57   |

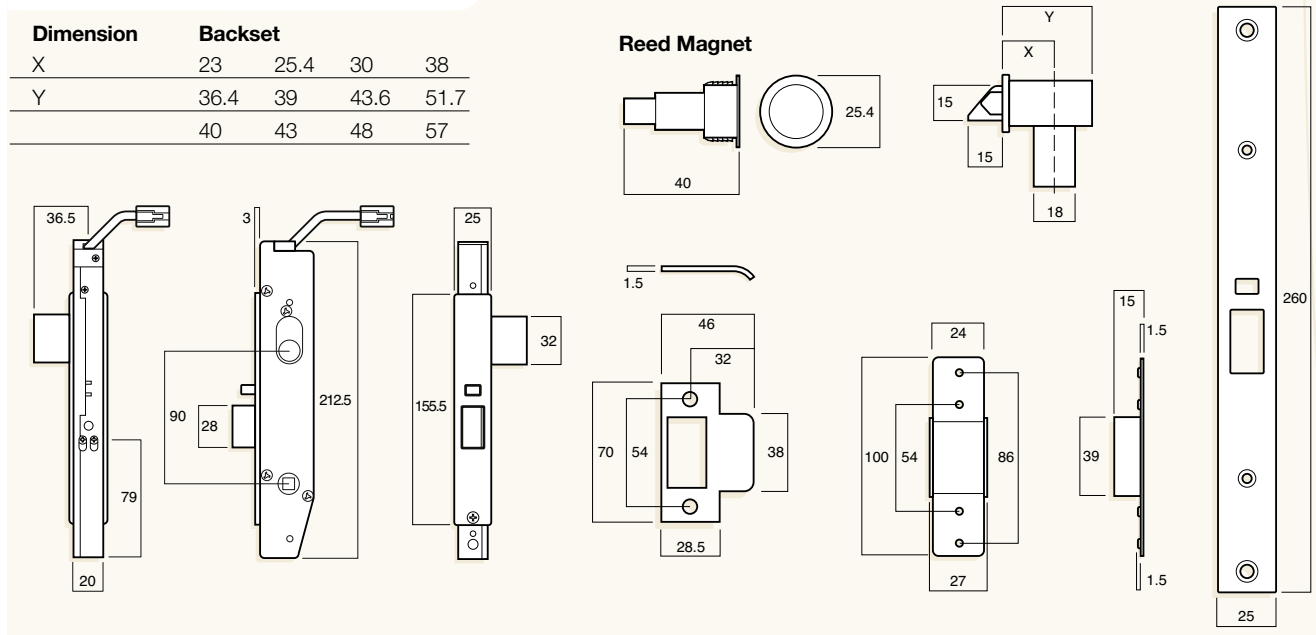

# 3500 Series Electric Mortice Lock

## 3580 Series Short Backset (continued)

### Ordering Procedure

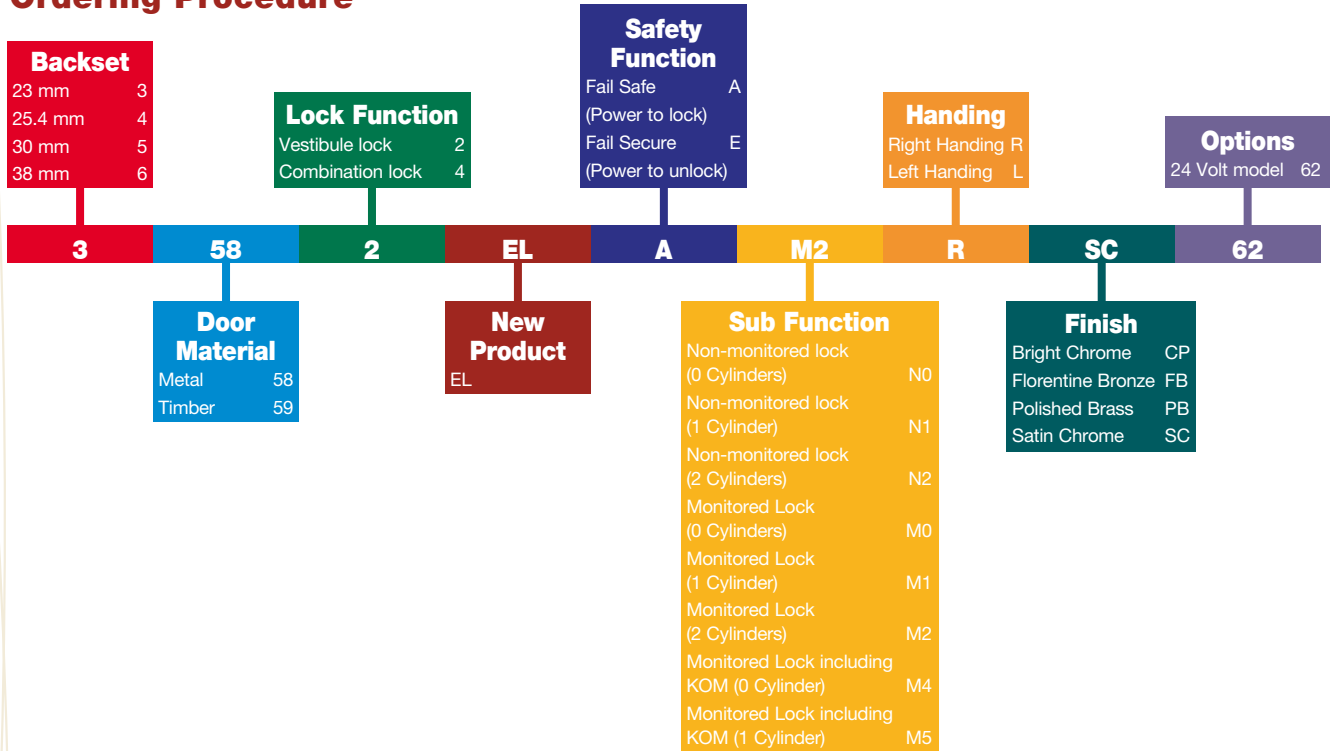

### Rebated Doors

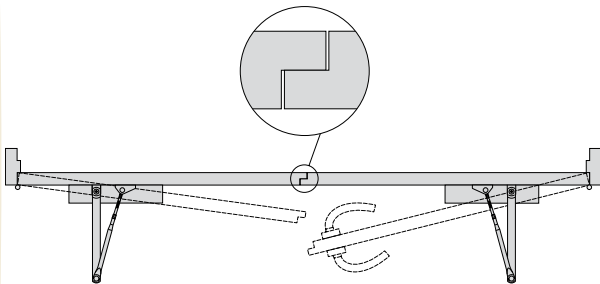

### Handing Chart

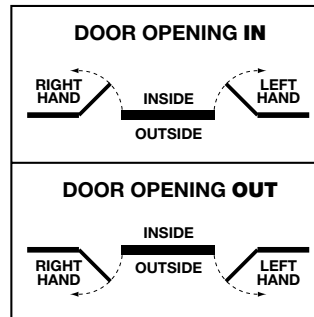

### Backset

Nominate backset as required, eg 23 mm

3

### Door Material

Nominate door material, eg Metal

358

### Lock Function

Select function, eg Vestibule Lock

3582

### Electrical Variant

Indicate that this is an Electric Lock - New Model

3582EL

### Safety Function

Select whether lock should Fail Secure or Fail Safe, eg Fail Safe

3582ELA

### Monitoring and Key Override Options

Select monitoring and cylinders to be supplied, eg Monitored Lock with Key Override

3582ELAM2

### Handing

Determine left or right handing, eg Right Handed

3582ELAM2R

### Finish

Specify appropriate finish, eg Satin Chrome

3582ELAM2RSC

### Options

Specify 24VDC option when required

3582ELAM2RSC62

# 3500 Series Electric Mortise Lock

## 3580 Series Short Backset (continued)

### Accessories

#### Rebate Kits

Rebate kits to suit 13 mm rebated timber doors with a minimum backset of 30 mm includes an adaptor to mount the lock and a special strike plate. Handing of the rebate kits is determined by the opening movement of the door on which the lock is fitted.

#### Part no.

| Finish         | Anti-clockwise | Clockwise     |
|----------------|----------------|---------------|
| Satin Chrome   | 3580-2902ACWSC | 3580-2902CWSC |
| Bright Chrome  | 3580-2902ACWCP | 3580-2902CWCP |
| Polished Brass | 3580-2902ACWPB | 3580-2902CWPB |

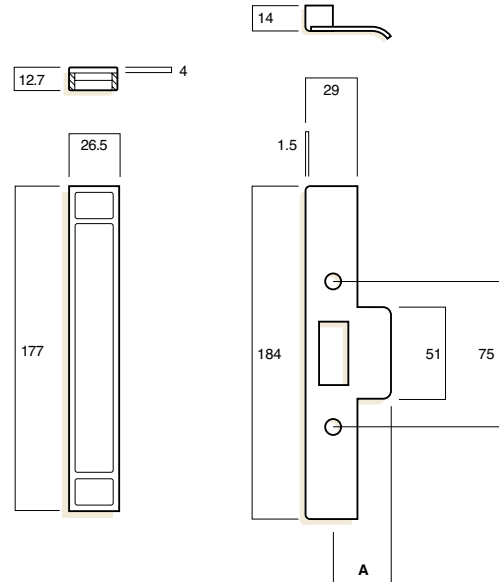

### Extended Cylinders

Extended cylinders should be considered when door thickness exceeds 50 mm or when the lock is mounted off centre in the door edge. A range of cylinders is available to suit various door thicknesses.

Refer to ASSA ABLOY Australia Keying and Restricted Price List for further information.

| "A"<br>Cylinder<br>Projection | Cylinder<br>Length | Recommended<br>Door Thickness<br>(Lock Central) |
|-------------------------------|--------------------|---|
| 41                            | 37                 | 50 to 60  |
| 52                            | 48                 | 60 to 84  |
| 64                            | 60                 | 84 to 108                                       |
| 80                            | 76                 | 108 to 132                                      |
| 88                            | 84                 | 132 to 156                                      |

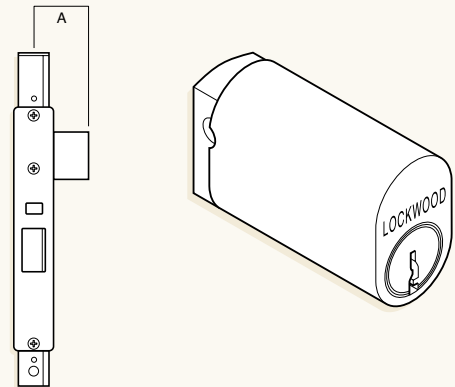

ASSA ABLOY is the global leader in door opening solutions, dedicated to satisfying end-user needs for security, safety and convenience.



www.assaabloyasiapacific.com  
www.lockweb.com.au

## ASSA ABLOY Sales Offices & Authorised Agents in Asia Pacific

### Sales Offices - Australia

#### Victoria – Head Office

235 Huntingdale Road  
Oakleigh VIC 3166  
Telephone (03) 8574 3888  
Facsimile (03) 8574 3788

#### Queensland South

450 Sherwood Road  
Sherwood QLD 4075  
Telephone (07) 3373 5200  
Facsimile (07) 3373 5256

#### Queensland North

Ralph Buck Agencies  
15 Mackley Street  
Garbutt QLD 4814  
Telephone (07) 4779 0177  
Facsimile (07) 4775 1480

#### New South Wales – Commercial

Unit 1/16 Atkinson Road  
Taren Point NSW 2229  
Telephone (02) 8543 3700  
Facsimile (02) 9531 7944

#### New South Wales – Residential

Unit 8/20-22 Foundry Road  
Seven Hills NSW 2147  
Telephone (02) 9624 2666  
Facsimile (02) 9620 9340

### New South Wales – Abloy

5/372 Eastern Valley Way  
Chatswood NSW 2067  
Telephone (02) 9882 6066

#### South Australia

182 Magill Road  
Norwood SA 5067  
Telephone (08) 8139 0401  
Facsimile (08) 8364 1975

#### Western Australia

37-45 Gladstone Street  
Perth WA 6000  
Telephone (08) 9227 9588  
Facsimile (08) 9227 8913

#### Tasmania

23 Antill Street  
South Hobart TAS 7000  
Telephone (03) 6223 5404  
Facsimile (03) 6224 0435

### Sales Offices - New Zealand

#### Auckland

6 Armstrong Road  
Albany  
North Shore City 0632,  
New Zealand  
Residential product enquiries  
Telephone +64 (0)9 415 7888  
Facsimile +64 (0)9 415 7889

Commercial product enquires  
Telephone +64 (0)9 622 4804  
Facsimile +64 (0)9 622 4802

#### Christchurch

112 Wordsworth Street  
Sydenham  
Christchurch 8023, New Zealand  
Telephone +64 (0)3 379 4810  
Facsimile +64 (0)3 379 4819

#### Wellington

Level 3, 10 Hutt Road,  
Petone  
Lower Hutt 5012,  
New Zealand  
Telephone +64 (0)4 913 4214  
Facsimile +64 (0)4 913 4213

### Manufacturing Plants



#### Victoria

235 Huntingdale Road  
Oakleigh VIC 3166  
Telephone (03) 8574 3888  
Facsimile (03) 8574 3788



#### Queensland

450 Sherwood Road  
Sherwood QLD 4075  
Telephone (07) 3373 5200  
Facsimile (07) 3373 5256



### New Zealand

6 Armstrong Road  
Albany  
North Shore City 0632,  
New Zealand  
Telephone +64 (0)9 415 7111  
Facsimile +64 (0)9 415 7222

### Security Merchants Australia

Unit 144/45 Gilby Road  
Axxess Business Park  
Mount Waverley,  
Victoria 3149  
Telephone +61 (0)3 9558 8455  
Facsimile +61 (0)3 9558 8466

### Security Merchants New Zealand

8-10 Haultain Street  
Eden Terrace  
Auckland, New Zealand  
Telephone +64 (0)9 355 9240  
Facsimile +64 (0)9 307 1752

### Export Department

235 Huntingdale Road  
Oakleigh VIC 3166 Australia  
Telephone +61 (0)3 8574 3888  
Facsimile +61 (0)3 8574 3789

### Asian Offices

ASSA ABLOY – Malaysia  
ASSA ABLOY – Singapore  
ASSA ABLOY – Thailand  
ASSA ABLOY – Hong Kong  
ASSA ABLOY – Shanghai  
ASSA ABLOY – Beijing  
ASSA ABLOY – Korea  
ASSA ABLOY – India  
ASSA ABLOY – Japan

Contact the Export Department,  
Australia for details.

### Worldwide Distributors

Contact the Export Department,  
Australia for details.

### Lockwood Warranty

ASSA ABLOY Australia Pty Limited ("ASSA ABLOY") warrants its Lockwood products against defects in workmanship and materials, subject to the limitations and exclusions set out in this Warranty. If, within the normal working life of a product, it is found to be defective, and none of the limitations and exclusions set out in this Guarantee apply, ASSA ABLOY will supply the same or equivalent product free of charge. This is the only remedy granted by ASSA ABLOY under this Warranty.

#### Limitations

All electrical and electronic components used in ASSA ABLOY's Lockwood range of products (excluding batteries) are guaranteed for a period of 12 months from the date of proof of purchase, unless stated otherwise.

#### Exclusions

This Warranty does not cover:

1. Damage to or malfunction or failure of the Lockwood product caused or contributed to by:

- improper installation or failure to follow fitting instructions;
- improper maintenance;
- fair wear and tear;
- any modification or repair which has not been authorized by ASSA ABLOY;
- use of substitute or replacement parts or cylinders other than genuine ASSA ABLOY parts or cylinders; or
- use of batteries other than those specified by ASSA ABLOY.

2. The cost of:

- removal and/or replacement of the Lockwood product;
- freight and/or travelling time;
- replacement batteries; or
- any modification or repairs to a Lockwood product, unless authorised by ASSA ABLOY.

3. Damage to or deterioration of the plated finishes Florentine Bronze, Architectural Bronze, Polished Brass, Gold and Satin Brass, which are classified as soft finishes, and are subject to deterioration under some environmental conditions.

4. Personal injury, property damage or economic loss, however caused.

#### Symmetry® 5 Year Finish Warranty

ASSA ABLOY Australia Pty Limited will replace five-year branded Symmetry product if within five years from the proven date of purchase it tarnishes, discolours or corrodes when properly installed and subject to no more than fair wear and tear.

#### Symmetry® Everbrass® Warranty

Everbrass® product is coated both on the exterior and interior surfaces with a lifetime anti-tarnish finish. ASSA ABLOY Australia Pty Limited will replace Everbrass® branded product if it corrodes, tarnishes or discolours when properly installed and subject to no more than fair wear and tear.

This Warranty is in addition to and not in substitution for any rights of the purchaser under the Trade Practices Act and state or territory legislation.

ASSA ABLOY Australia Pty Limited ABN 90 086 451 907

